

**EN** - Please read this instruction manual carefully before attempting to install.

**DE** - Bitte lesen Sie diese Bedienungsanleitung vor der Montage gründlich durch.

**ES** - Por favor lea con atención el manual de instrucciones antes de llevar a cabo el ensamble.

**FR** - Lisez attentivement cette notice avant de commencer le montage.

**IT** - Si prega di consultare il libretto delle istruzioni prima del montaggio.

# IMPORTANT/WICHTIG/ATENCIÓN

## IMPORTANT/IMPORTANTE



**EN** - We recommend **1** or more people to install.  
**DE** - Wir empfehlen, dass die Montage von **1** oder mehreren Personen durchgeführt werden sollte.  
**ES** - Recomendamos realizar el ensamble con **1** o más personas.  
**FR** - Il est recommandé d'effectuer le montage à **1** personne(s) ou plus.  
**IT** - È necessaria la presenza di **1** o più persone per il montaggio di questo prodotto.



**EN** - The expected assembly time is **1 h**.  
**DE** - Die Montagezeit beträgt durchschnittlich **1 h**.  
**ES** - El tiempo aproximado de ensamble es de **1 h**.  
**FR** - Le temps nécessaire est estimé à **1 h**.  
**IT** - Il tempo previsto per il corretto assemblaggio è di **1 h**.



**EN** - Not intended for use by children.  
**DE** - Nicht geeignet für Kinder.  
**ES** - Producto no apto para niños.  
**FR** - Produit non destiné à être utilisé par des enfants.  
**IT** - Questo prodotto non è destinato all'uso da parte dei bambini.



**EN** - Keep away from fire or other heat sources.  
**DE** - Bitte von Feuer und Hitzequellen fernhalten.  
**ES** - Manténgase alejado de las llamas y otras fuentes de calor.  
**FR** - Tenir à distance des flammes et autres sources de chaleur.  
**IT** - Tenere lontano dal fuoco o da altre fonti di calore.



**EN** - We recommend wearing protective gloves.  
**DE** - Wir empfehlen das Tragen von Schutzhandschuhen.  
**ES** - Recomendamos el uso de guantes de seguridad.  
**FR** - Il est recommandé de porter des gants de protection.  
**IT** - Per il processo di assemblaggio, consigliamo fortemente l'utilizzo di guanti protettivi.

**EN** - Please follow the instruction manuals and use a pad to avoid damage during assembly.









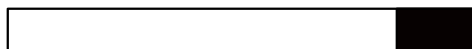
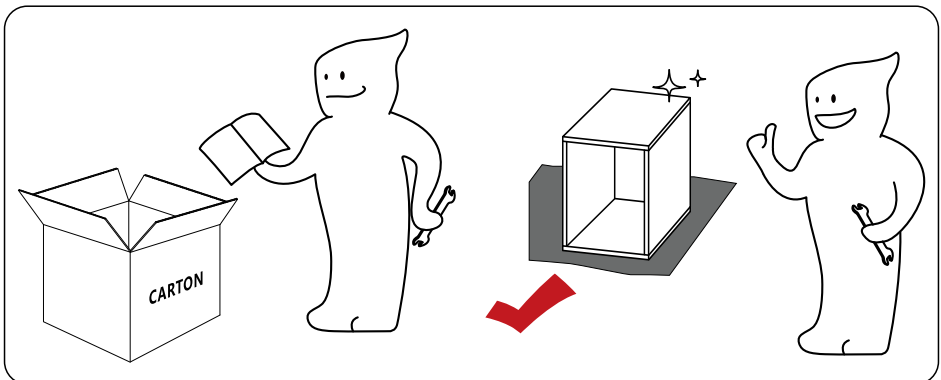
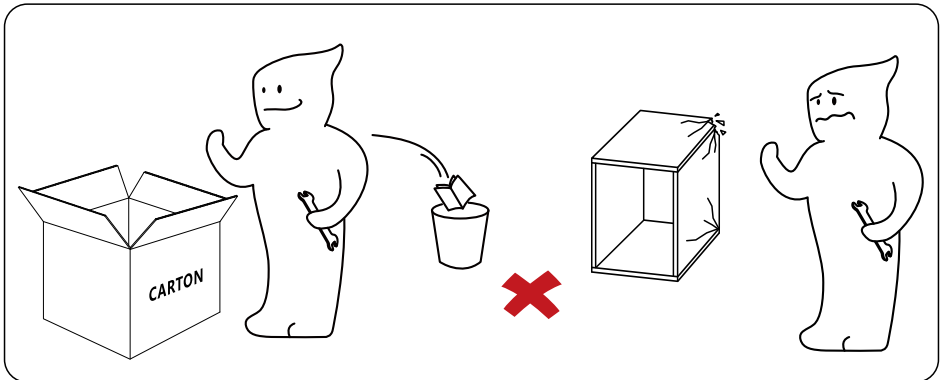



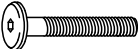

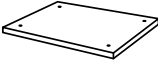
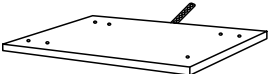
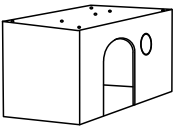
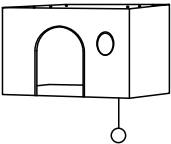

**DE** - Bitte folgen Sie der Anleitung und verwenden Sie eine Unterlage, um Beschädigungen bei der Montage zu vermeiden.

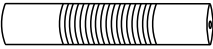
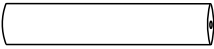
**ES** - Por favor siga las instrucciones del manual y utilice una cubierta o lona para proteger el producto y los suelos durante la instalación.

**FR** - Suivez les instructions de la notice et utilisez une couverture ou une bâche pour protéger le produit et les sols pendant le montage.



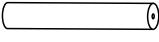

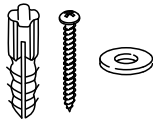
**IT** - Si prega di consultare il manuale illustrativo durante il montaggio e di utilizzare un cuscinetto per evitare possibili danni.

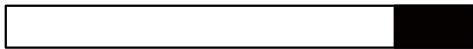

<p>① × 1</p> 	<p>② × 2</p> 	<p>③ × 35</p> 	<p>④ × 1</p> 	<p>⑤ × 1</p> 
<p>⑥ × 1</p> 		<p>⑦ × 1</p> 	<p>⑧ × 1</p> 	
<p>⑨ × 1</p> 	<p>⑩ × 1</p> 	<p>⑪ × 1</p> 		
<p>⑫ × 2</p>  <p>45CM</p>	<p>⑬ × 2</p> 	<p>⑭ × 1</p>  <p>38.5CM</p>		
<p>⑮ × 2</p>  <p>29CM</p>	<p>⑯ × 2</p> 	<p>⑰ × 1</p> 		
<p>⑱ × 1</p> 	<p>⑲ × 8</p>  <p>27CM</p>	<p>⑳ × 1</p> 	<p>㉑ × 1</p> 	





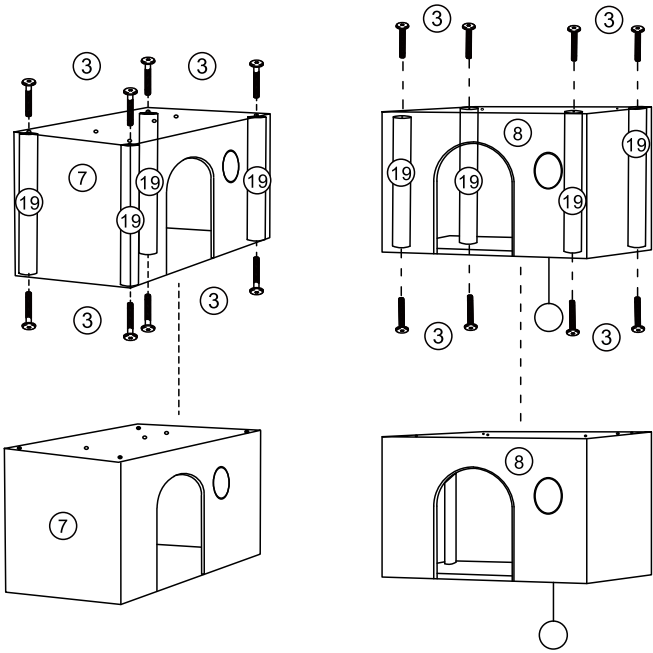

# 1

③		x16
⑦		x1
⑧		x1
⑱		x8



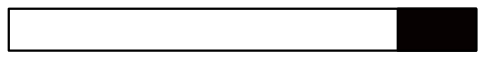
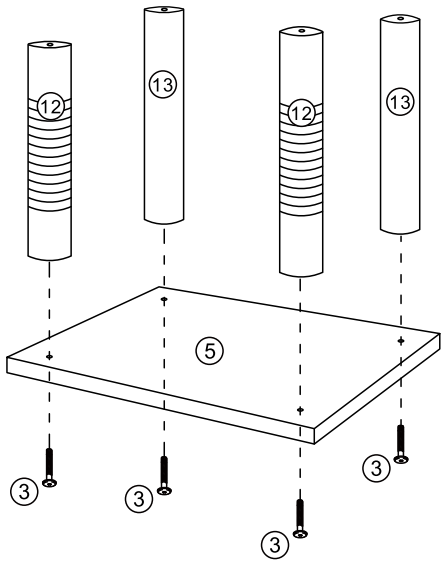

# 2

③		x4
⑤		x1
⑫		x2
⑬		x2



3

⑥		x1
⑳		x1

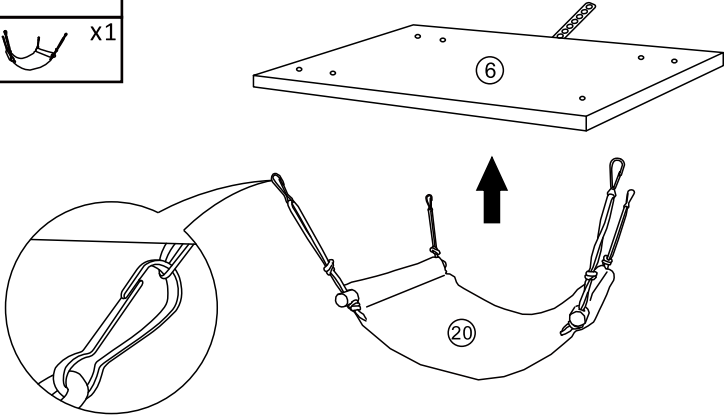

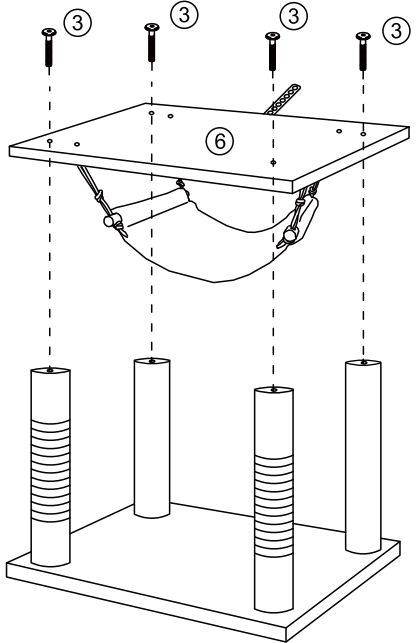

4

③		x4
---	-----------------------------------------------------------------------------------	----



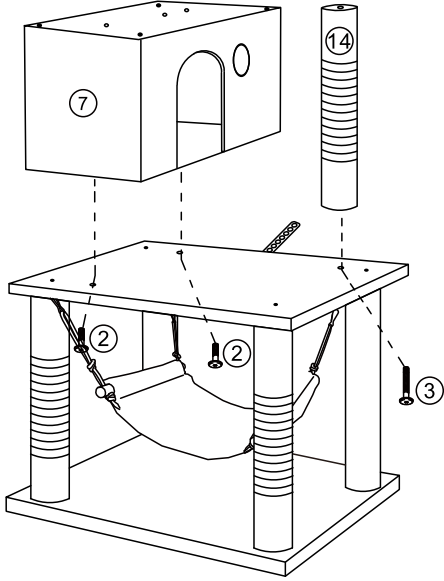

5

②		x2
③		x1
⑭		x1





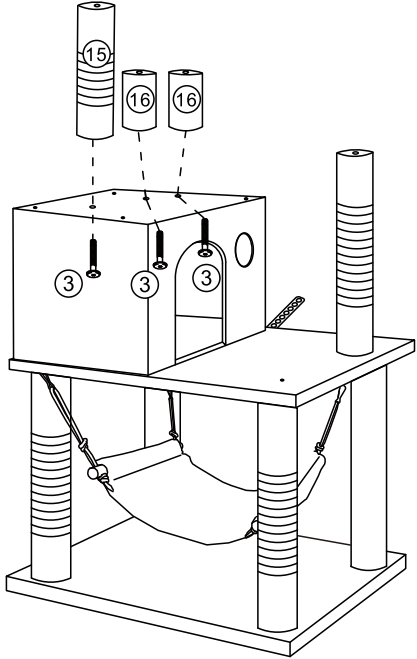

6

③		x3
⑮		x1
⑯		x2



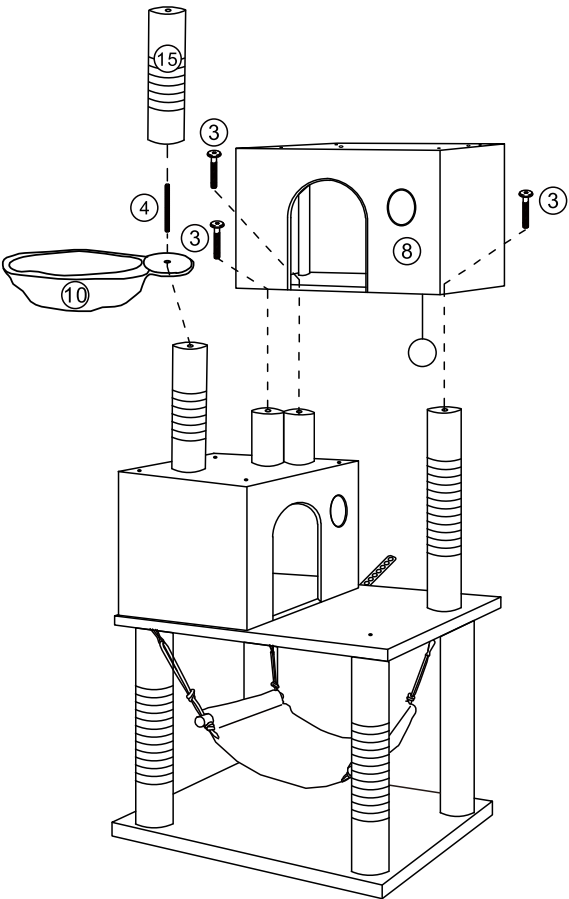
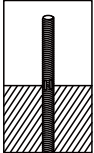
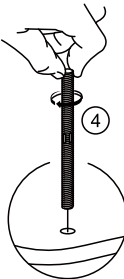
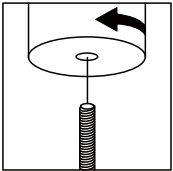

7

③		x3
④		x1
⑩		x1
⑮		x1





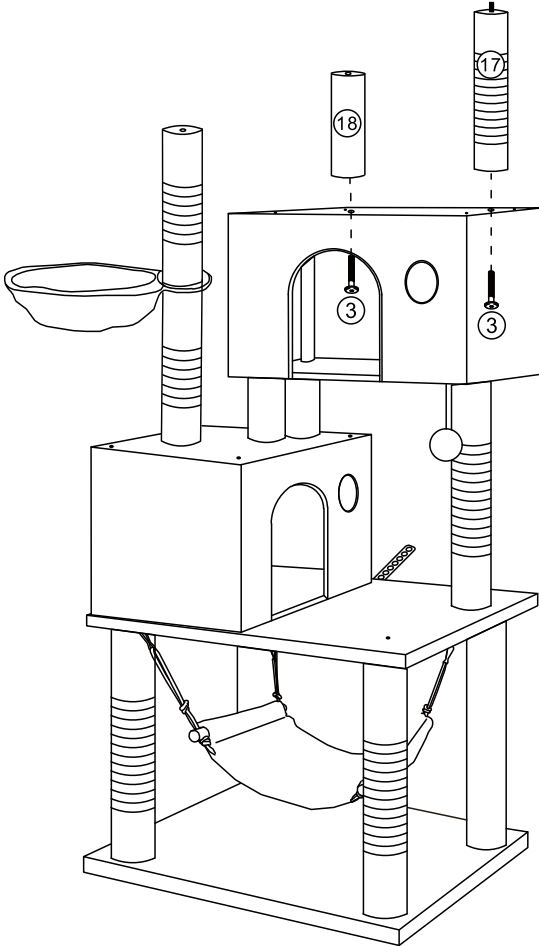

8

③		x2
⑰		x1
⑱		x1



9

③		x2
⑨		x1
⑪		x1

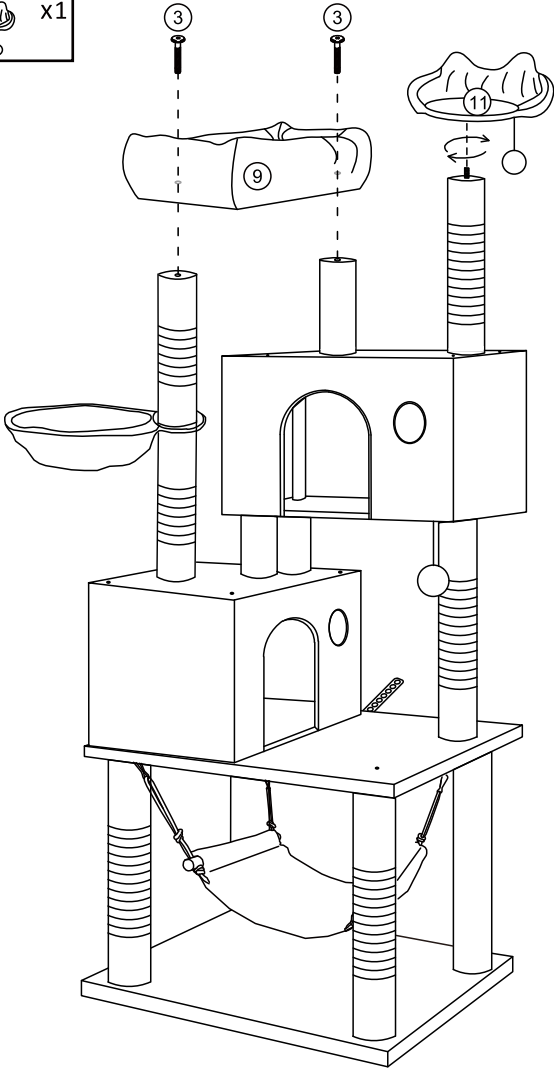

10

